

CB - KNOCKOUT

KNOCKOUT CATCH BASIN

SUMP	1'6", 2', 2'6", 3', AND 4'
K/O RISER	3' AND 4'
CONE	6", 8", 12", AND 18"
K/O W/ CTRANS	2', 2'6", 3', 3'6" AND 4'

DESIGN NOTES

1. CONCRETE -5000 PSI, 28 DAYS
2. REINFORCEMENT - ASTM A-615, GRADE 60
3. OPTIONAL GALVANIZED FRAME & GRATE
4. RISER WITH CB OPNG
CL TOP - 2'8 3/4" X 1'8 1/2" OPENING
C TOP - 2'8 3/4" X 2'1 1/2" OPENING

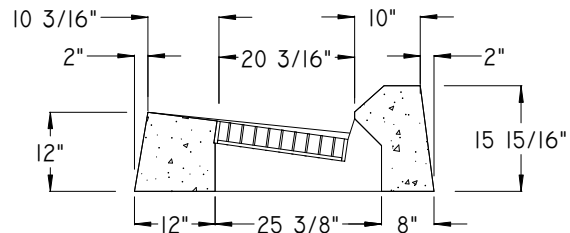
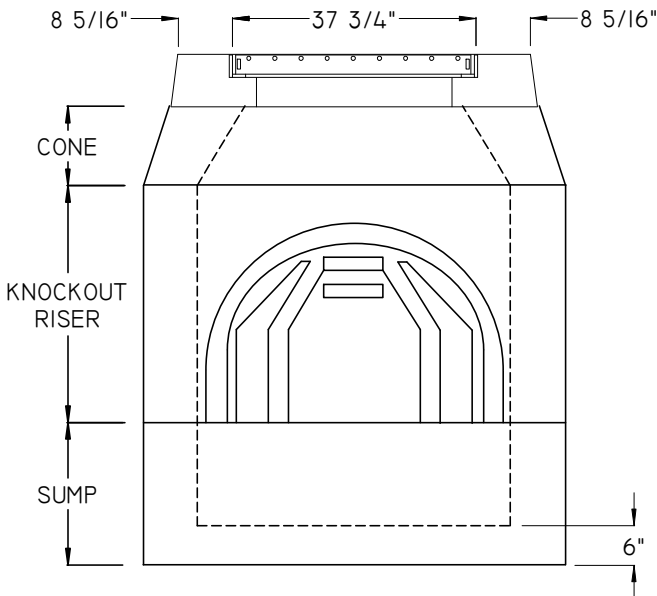
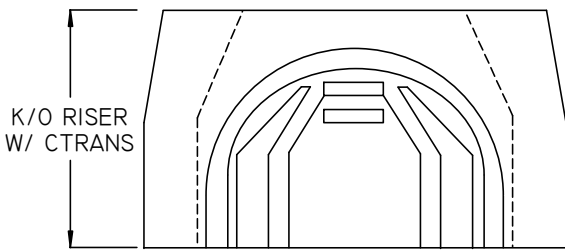
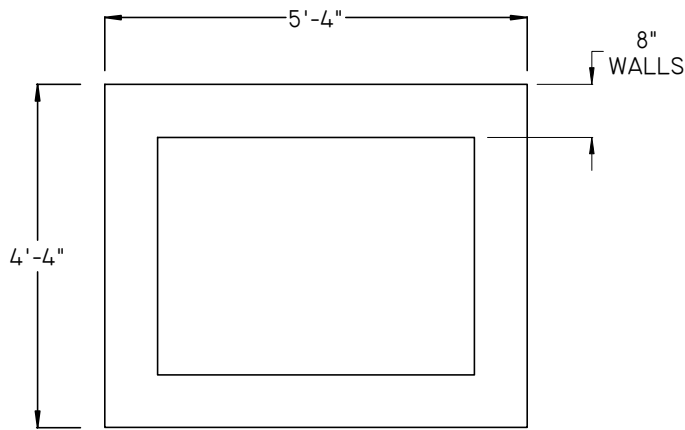

BITUMINOUS CURB TOP

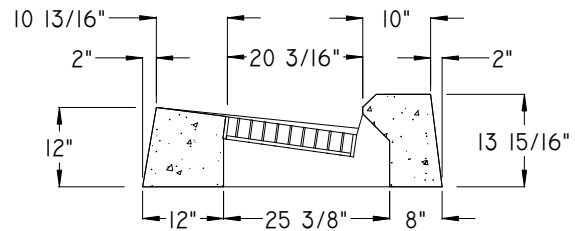

PARK CURB TOP

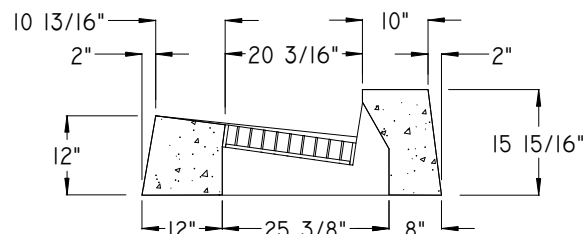

CONCRETE CURB TOP

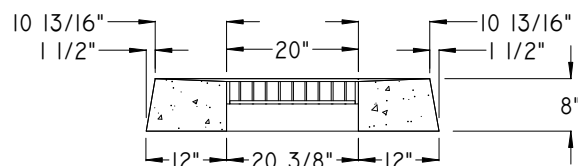

FLAT TOP